

Progress on the 8-40 GHz Wideband Instrument for Snow Measurements (WISM)

NASA ROSES Instrument Incubator Program

Presented by: Tim Durham¹, PI

Contributors: Kerry Speed¹, Art Olsen¹, Robert Lange¹, Paul Racette², Quenton Bonds², Ken Vanhille³, Leung Tsang⁴, Hans-Peter Marshall⁵, Felix Miranda², Kevin Lambert²

**Earth Science Technology Forum 2014
28-30 October 2014
Leesburg, VA**



- Program Overview
- Instrument Specification Overview
- Wideband Antenna
 - Design
 - Fabrication
 - Feed Measurement results
 - Secondary performance
- Instrument Design
 - Radar
 - Radiometer
- Conclusions
 - Accomplishments
 - 2013 IIP work plan

NASA WISM ROSES IIP Overview



- Harris leading a NASA ROSES (Research Opportunities in Space and Earth Sciences) IIP (Instrument Incubator Program)
 - Currently in second round of funding
- Developing the science and technology needed to carry out a remote sensing mission to make snow measurements from both airborne and space platforms
- Snow and Cold Land Processes (SCLP) mission concept from NASA Decadal Survey uses four instruments to gather data on snow pack extent and characteristics (depth, density, snow water equivalent (SWE))
- Existing antenna concept uses reflector antennas fed by individual feeds for each frequency/beam
 - Multi-element feeds produce offset beams
- Demonstrated the technology to replace the feed manifold with a single array feed capable of supporting both SAR and radiometry
 - Performance improvement (i.e. co-boresighting)
 - Significant size, weight, power advantages

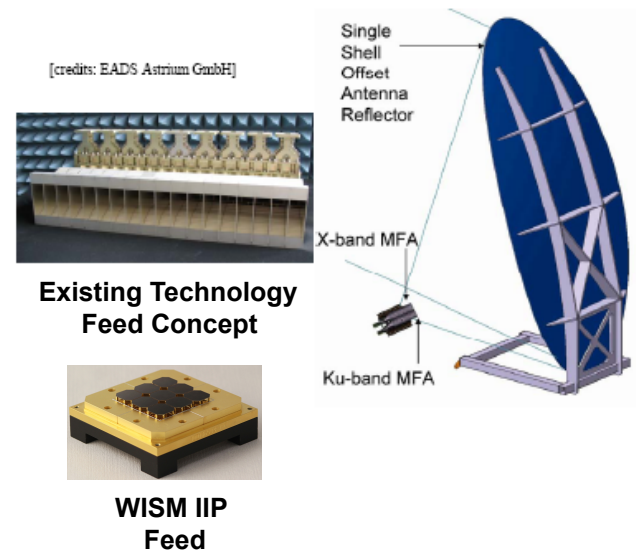
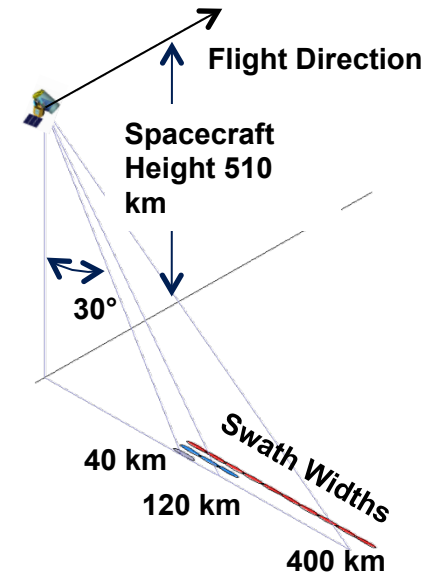

- Combine active and passive sensing technologies in a single instrument
 - Built a multi-band radar/radiometer that utilizes the same antenna for four bands from X- to Ka- Band
 - Instrument is software reconfigurable for many important parameters
- Build wideband antenna
 - Implemented first version of Harris' Current Sheet Array (CSA) antenna that operates from 8-40 GHz
 - Fabricated the array aperture and RF components in the antenna
- Perform experiments
 - Ground based experiments in first IIP demonstrated antenna technology is compatible with wideband radars
 - Airborne experiments will demonstrate science of snow measurement using active/passive combined sensing

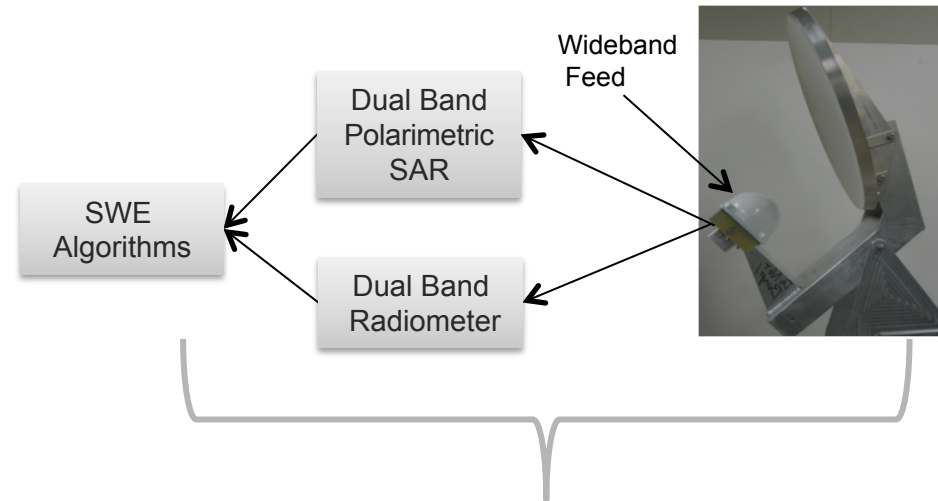

The Wideband Instrument for Snow Measurements (WISM)

Three Key Technical Objectives



- Design, build, and test 8-40 GHz wideband fixed beam feed for an offset reflector
- Design, build, and test multi-function instrument to support SAR and radiometry
 - X-band (Up-down, SAR)
 - Ku-band (Up-down, SAR)
 - K-band (Down, radiometer; addition based on science value)
 - Ka-band (Down, radiometer)
- Improve Snow Water Equivalent (SWE) measurement from space by developing new algorithms exploiting wideband antenna/instrument technology

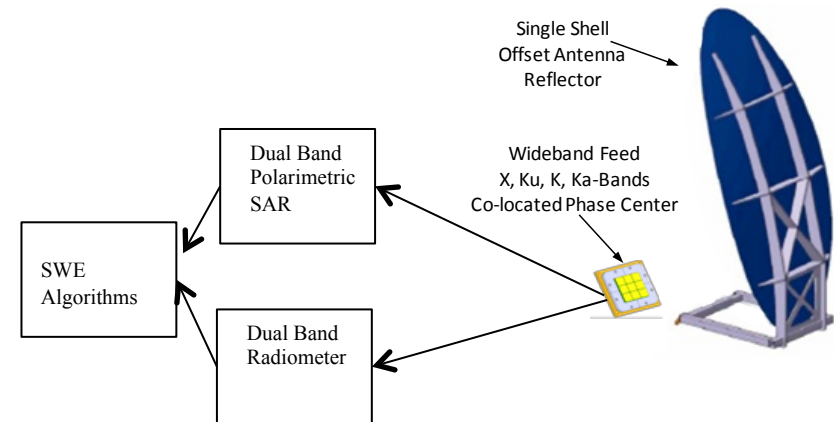

- Snow and Cold Land Processes (SCLP) is a decadal mission of NASA
- Decadal Tier 3 Mission: Earth Science and Applications from Space: National Imperatives for the Next Decade and Beyond
- Instruments
 - Active: X/Ku-bands SAR (9.6, 17.2 GHz)
 - Passive: Ku/Ka-bands radiometer (18.7, 36.5 GHz)
- Resolution: 50 – 100 m
- CLPX: cold land processes field experiment

	Year	Location
CLPX-1	Feb 2002 and March 2003	Rockies in upper Colorado
CLPX-2 Colorado	Nov 2006, Jan, Feb 2007, March 2008	Rockies in Northwest Colorado
CLPX-2 Alaska	Nov-Dec 2007, Feb 2008	North Slope, Alaska
CLPX-3	Oct-Nov 2009, Feb 2010	Grand Mesa, Colorado

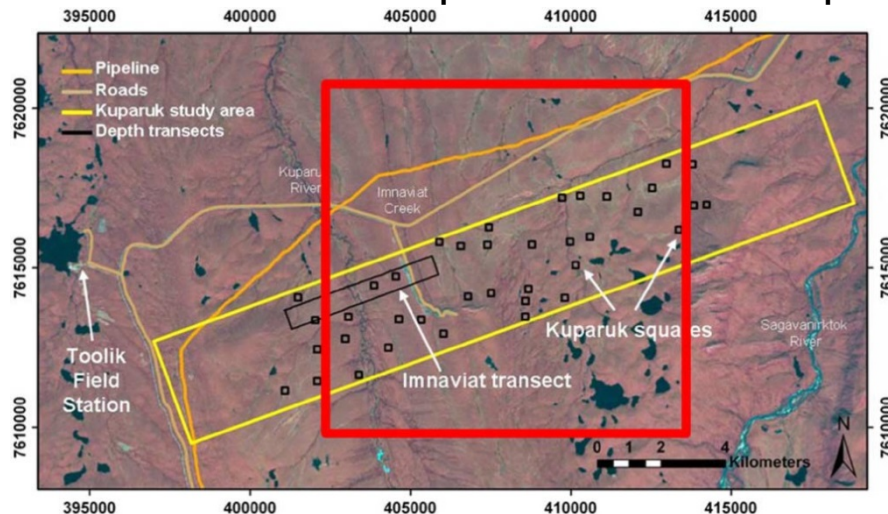

CLPX II, in Kuparuk River, Alaska. Yellow box is the POLSCAT Ku-band scatterometer coverage. Red box is the coincidental TerraSAR-X coverage. Black squares are the snowpit samples.

- Ground experiments in 1st/2nd/3rd years
- Carried out by HP Marshall of Boise State University
- Goal was initial demonstration of use of wideband antennas for SWE measurements
- Used both 2-18 GHz CSA antenna developed under Harris IR&D and Alpha Build antenna developed on this effort
- Utilized existing FMCW radars at Boise State to successfully measure snow depth and stratification
- Demonstrated improved measured results performance with narrower beam alpha build antenna



Snow depth measurement using FMCW Radar from skis and snowmobile

FMCW Radar Results using Harris CSA Array Antenna



8-18 GHz Harris Array Antenna, BSU Snow Research Plot, Feb 4, 2013

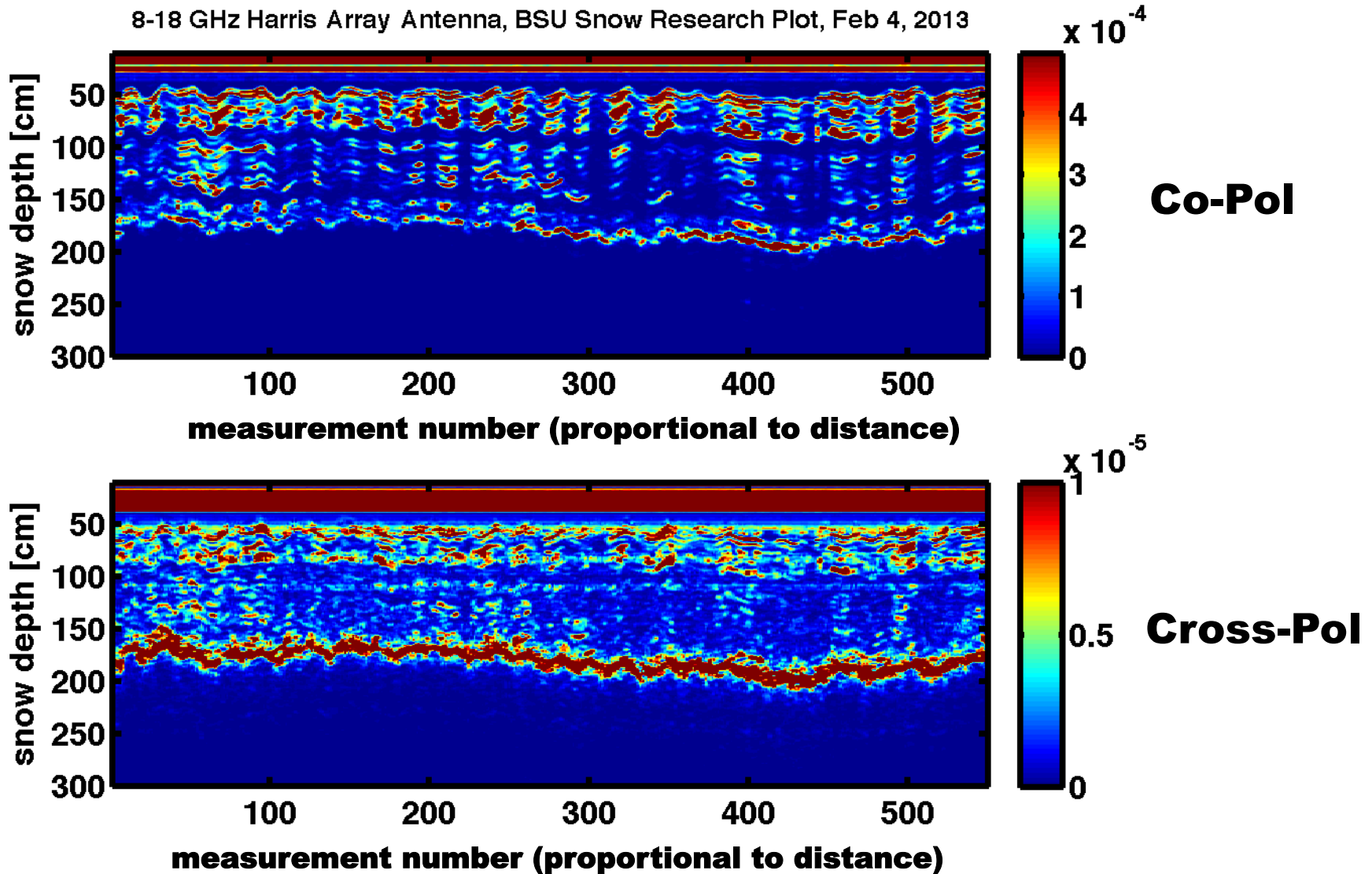

- Major requirements for system were defined by science team consistent with the goals defined in the decadal survey
 - Cold Land Processes Pathfinder
 - 50-100m resolution (minimum baseline)
 - Also provide a coarser sub-kilometer mode
 - Specific numbers:
 - Radar:
 - 10/17 GHz: 100m resolution, 40km swath width (single beam)
 - Radiometer:
 - 19 GHz: 7km resolution, 45km swath width (multiple beam)
 - 37 GHz: 4km resolution, 40km swath width (multiple beam)
 - WISM goals
 - 10m for airborne radar
 - < 100m for airborne radiometry
- Radar specifications were generated at three different levels of detail
 - Simple spreadsheet
 - Higher complexity spreadsheet
 - Highly detailed MATLAB analysis
- Radar analysis used to set reflector antenna size
 - Also sets radiometer resolution

SAR System Description & High Level Requirements



- Airborne Stripmap Synthetic Aperture Radar operating at X- and Ku-bands with 10 meter resolution
- Single polarization transmit (V), dual polarization receive (H,V)
- SAR images are formed via post-processing

SAR System Requirements		
Platform Altitude	9,184	ft
	2.80	km
Platform Speed	173	mph
	77	m/s
Frequency (center) X-Band	9.6	GHz
Frequency (center) Ku-Band	17.2	GHz
Tx BW (LFM)	27.1	MHz
Slant Range Resolution	6.7	m
	22.1	ft
Ground Range Resolution (near edge)	10	m
	32.8	ft
Cross Range Resolution	10	m
	32.8	ft
Antenna Diameter	0.340	m
	34.0	cm
	13.4	in
Antenna Efficiency	0.7	linear
	-1.5	dB
Noise Temp	290	deg K
PRF	1,100	Hz
Transmit Pulse Length	20	msec
Tx Power (peak)	5.0	Watts
Tx Power (average)	0.1	Watts
	-8.8	dBW

WISM Instrument Block Diagram

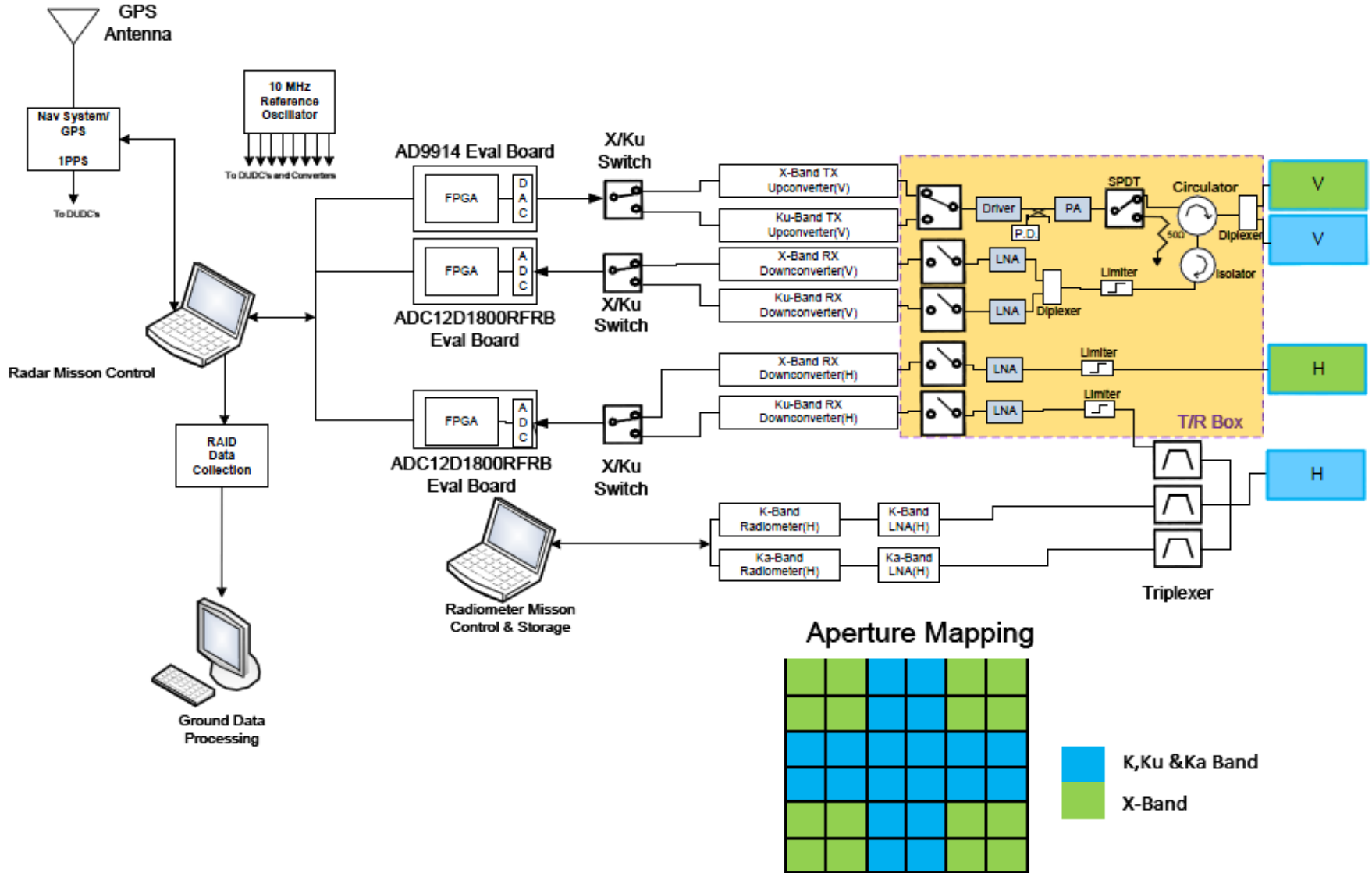

- Exploit wideband impedance matching principles to achieve bandwidths as large as 10:1
 - Emphasize periodic array environment over isolated element performance
 - Use coupling as a friend
 - Practical design developed at Harris over last 15 years
- TRL 4-8 for frequency ranges below 18 GHz
- Prior to this effort, most fabrication has been below 18 GHz



CSA is a phased array aperture: CSA systems model and behave like conventional phased arrays (scan, pattern, gain, etc.)

What is the PolyStrata® Technology?

3D Copper Coax with Air Dielectric

- Ultra-High-Density Interconnects
- Batch Processing for High Volume Production
- Unsurpassed RF Performance
- +/- 2µm Precision Lithography

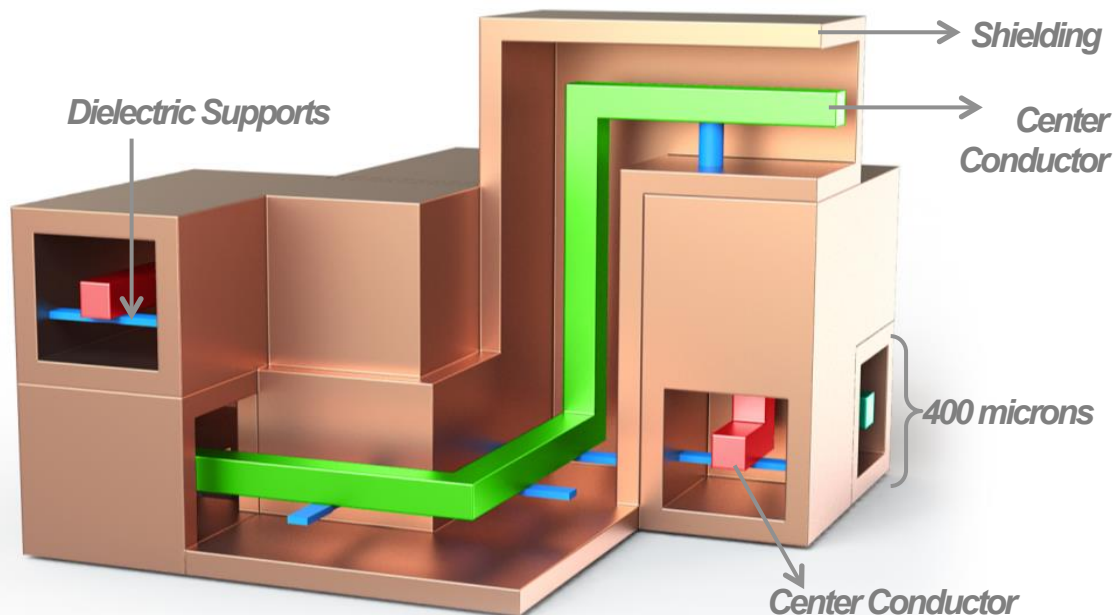

Wafer Scale Process

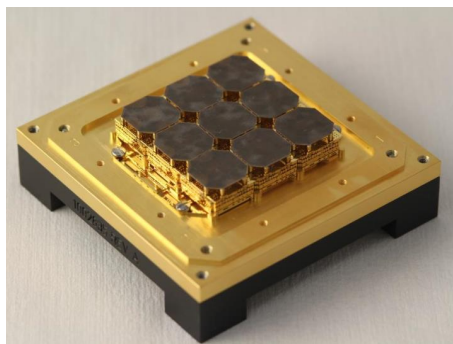

Pluggable, Reworkable,
Modular



Miniature Antennas &
RF Components

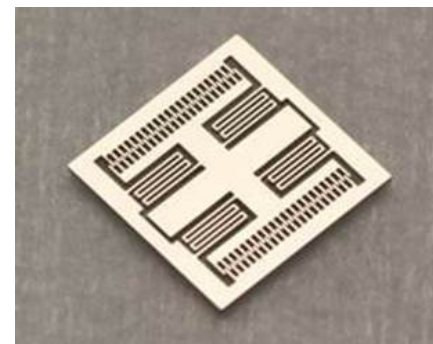

3D Metal MEMS

WISM Antenna Feed

1. Wafer-Level Process



2. Remove devices and Stack

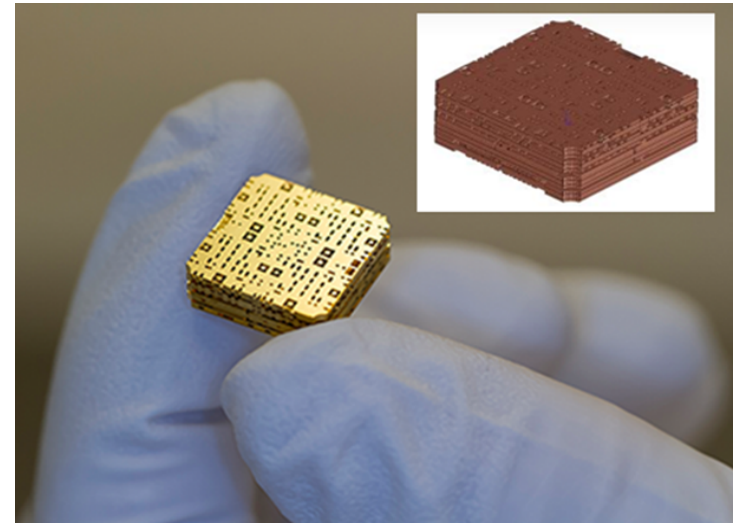

3. Testable Building Blocks

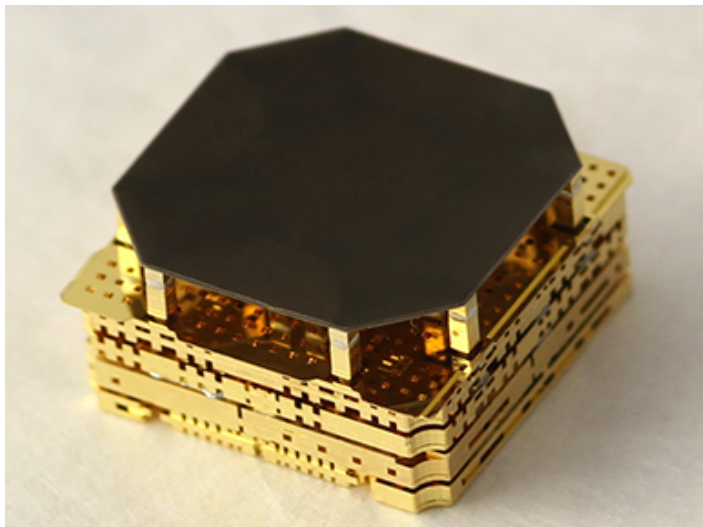

4. Create Higher-Level Assemblies

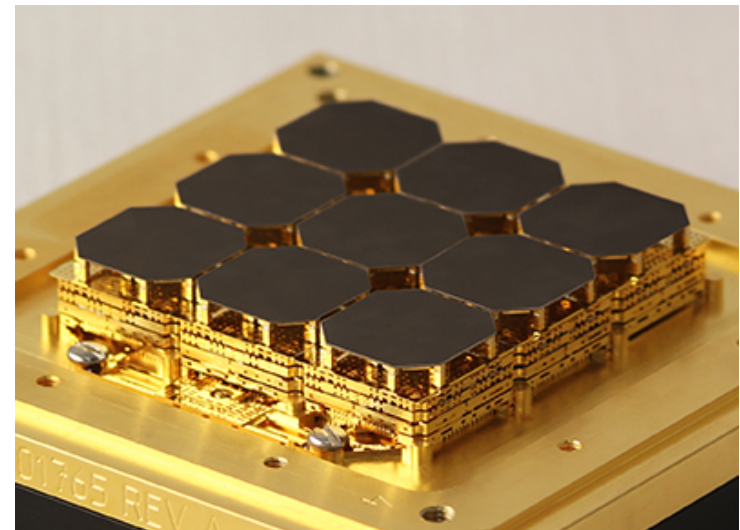

Antenna Feed: Schematic

- Nine 0.5" by 0.5" Modules
 - 36 Dual Polarized Antenna Elements
 - 36 X-Ka Band Baluns
 - 82 X-Ka Band Splitters
 - 8 Ku-Ka Band Splitters
 - 378 Stacked Vertical Interconnects
- One 1.5" by 1.5" Backplane
 - 8 Ku-Ka Band Reactive Splitters
 - Two Ku-Ka Band Delay Lines
 - 6 X-Ka Band Reactive Splitters
 - 4 Connections to 2.4mm Connectors

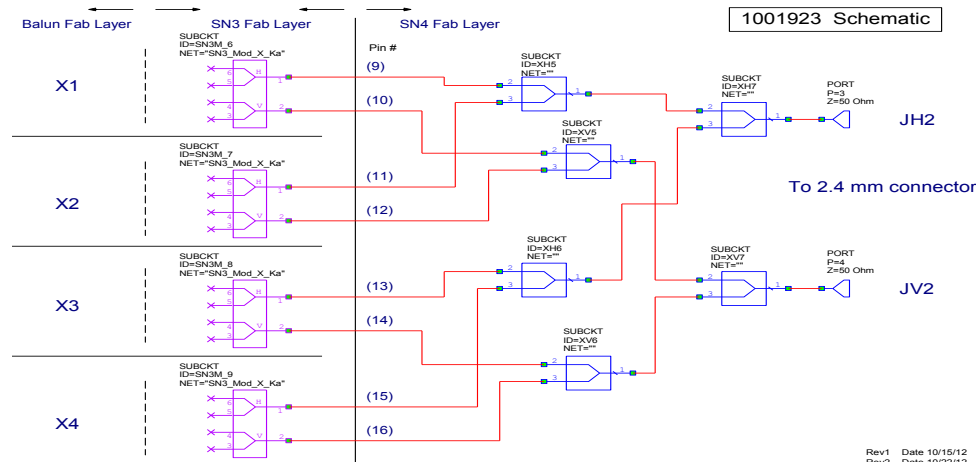
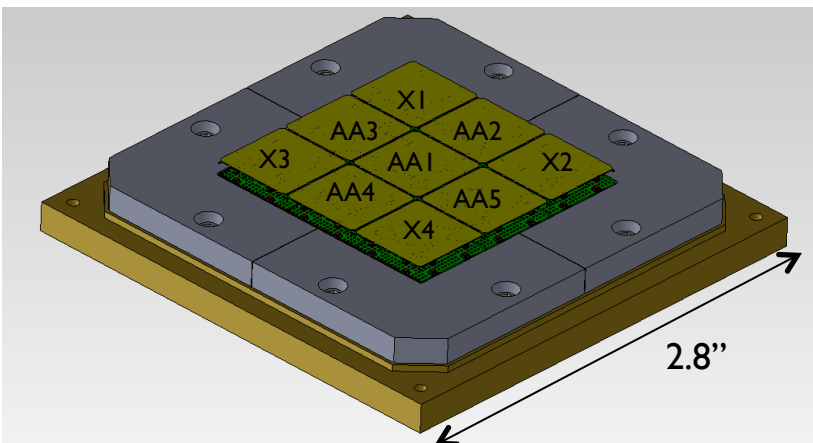
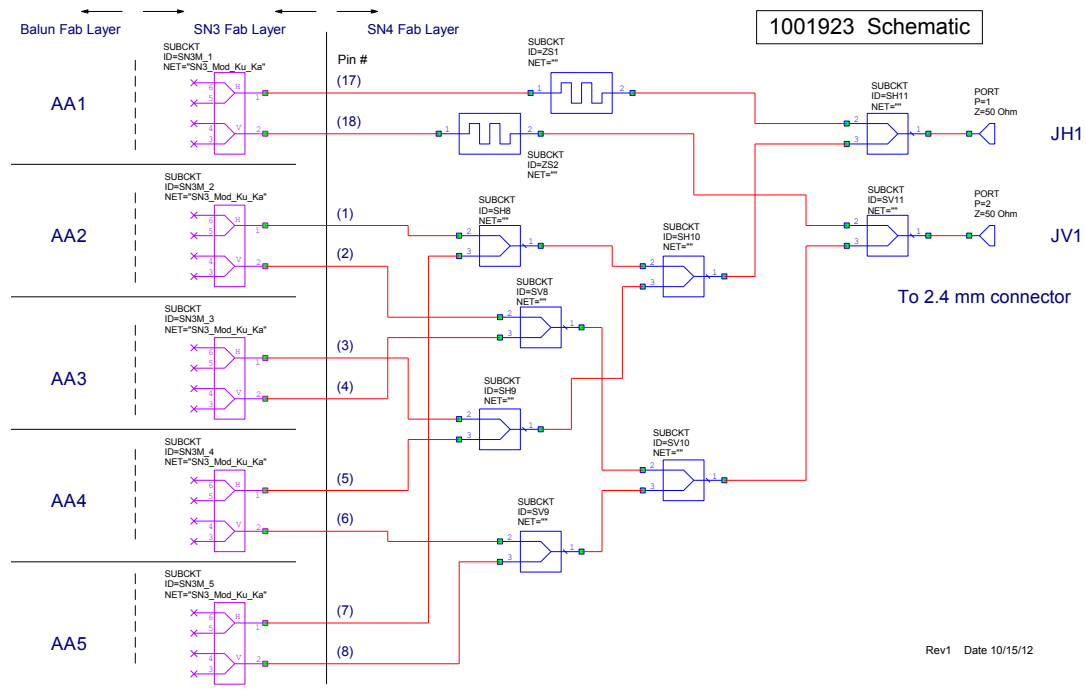

- Two X-to-Ka-band antenna feeds delivered to NASA GRC for radiation pattern measurements

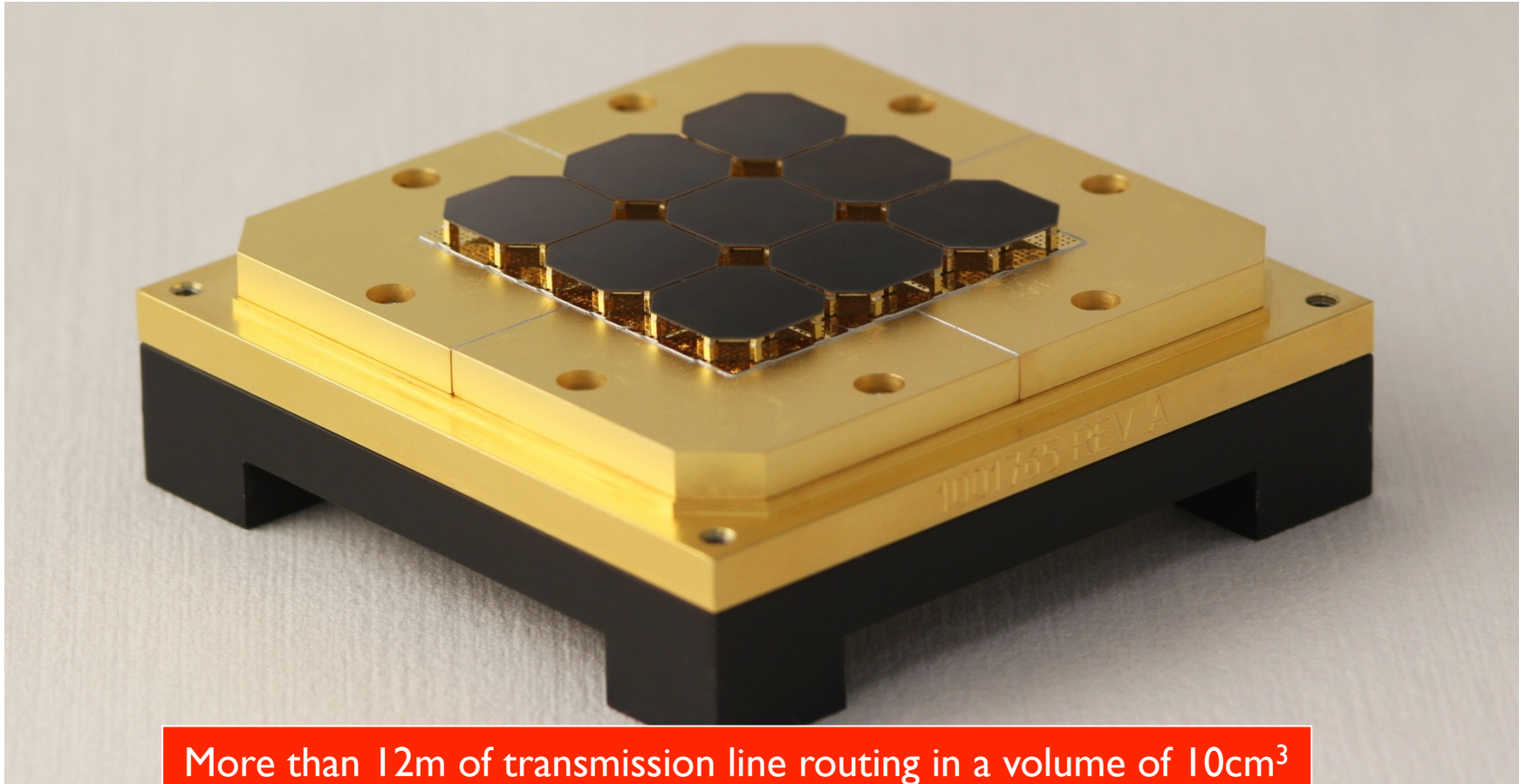

GRC Measurements of Final Build Antennas

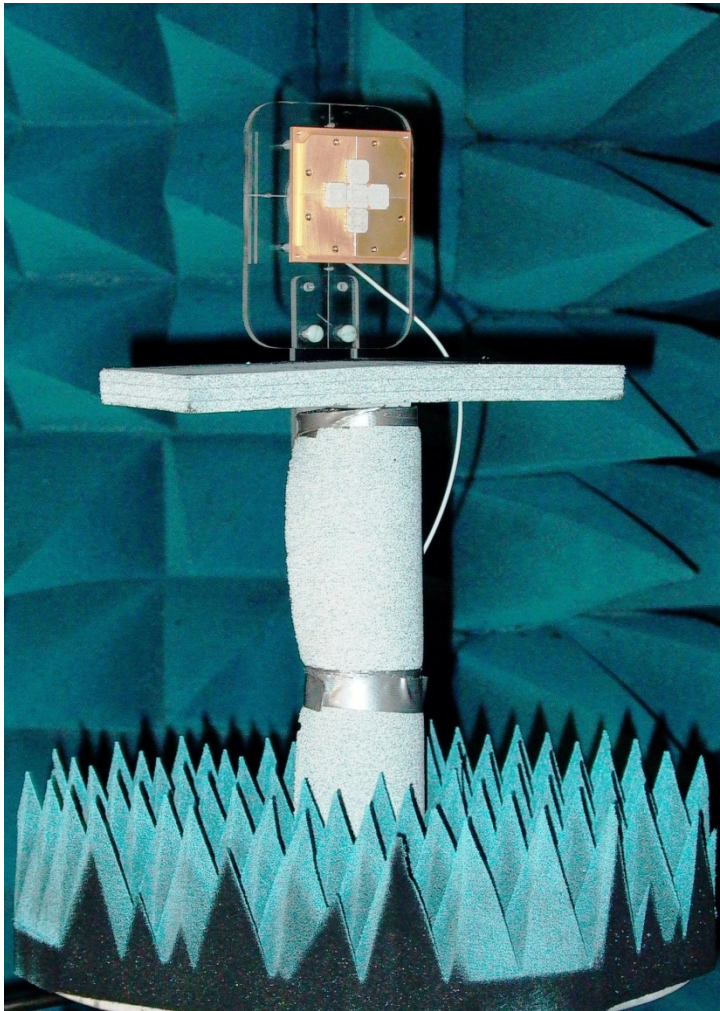

- Final Build CSA
 - Nine Modules
 - Four Ports
 - JH1/JV1 ports for central five module cross (K-, Ku-, Ka-Band)
 - JH2/JV2 ports for outer four corner modules combined (X-Band)
 - Radiation Patterns
 - Four Frequency Bands
 - X-Band (9.5 GHz - 9.8 GHz)
 - K_u-Band (17.2 GHz - 17.3 GHz)
 - K-Band (18.6 GHz – 18.8 GHz)
 - K_a-Band (36 GHz - 37 GHz)
 - Principal and intercardinal planes
 - Co-Polarized and Cross-Polarized
 - Magnitude and Phase
 - Four Ports
 - Gain
 - X, K_u, K, and K_a Frequency Bands
 - Each Port
 - Return Loss
 - 8 GHz – 40 GHz
 - Each Port

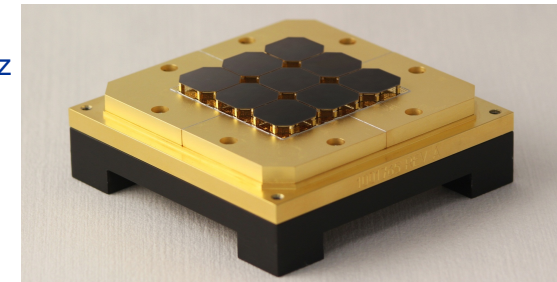

Wideband Reflector Feed: Antenna Measurements at X-Band

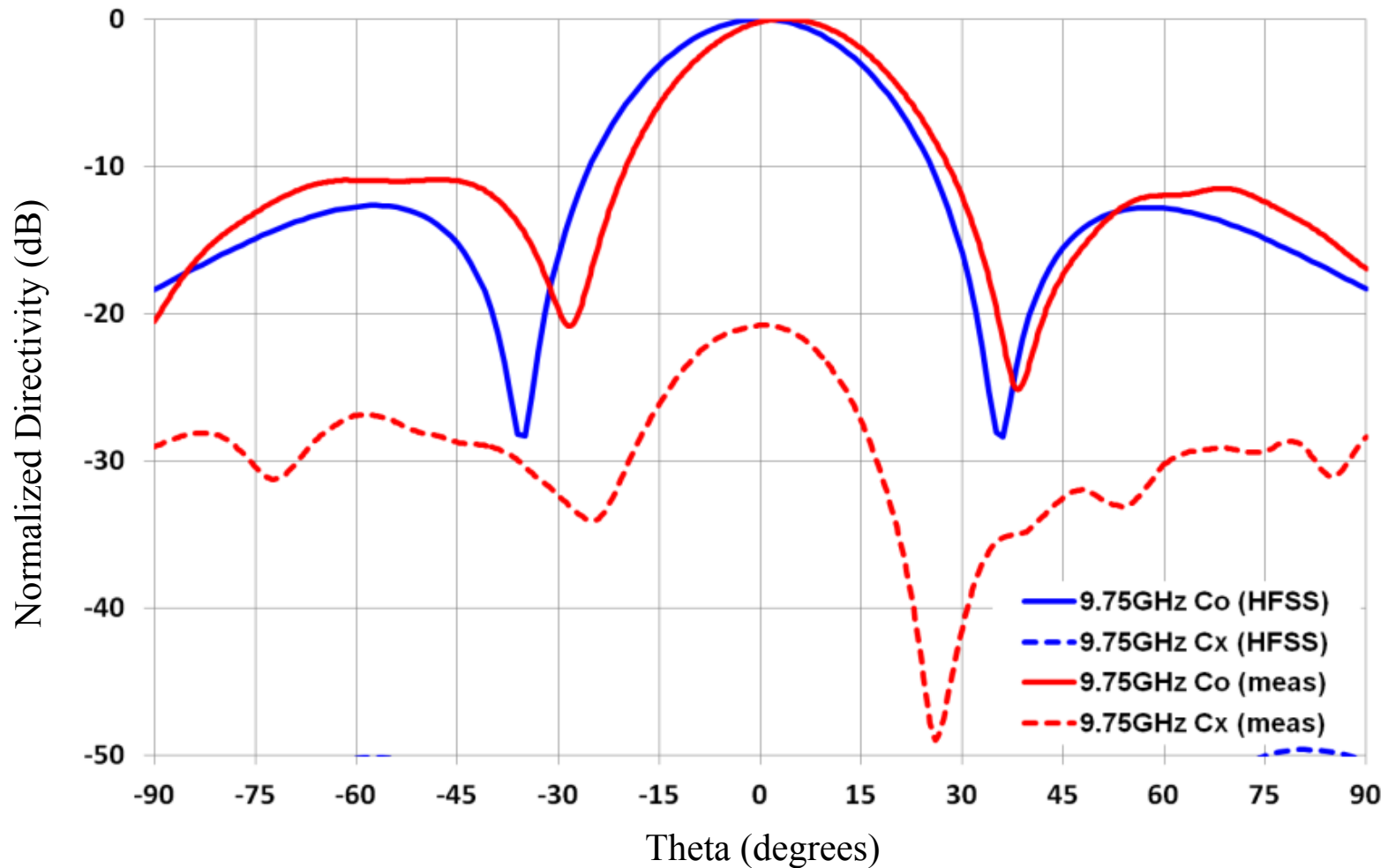

Measurements shown at 9.75GHz GHz, $\varphi=0^\circ$. Simulations performed using HFSS.

Wideband Reflector Feed: Antenna Measurements at Ku-Band

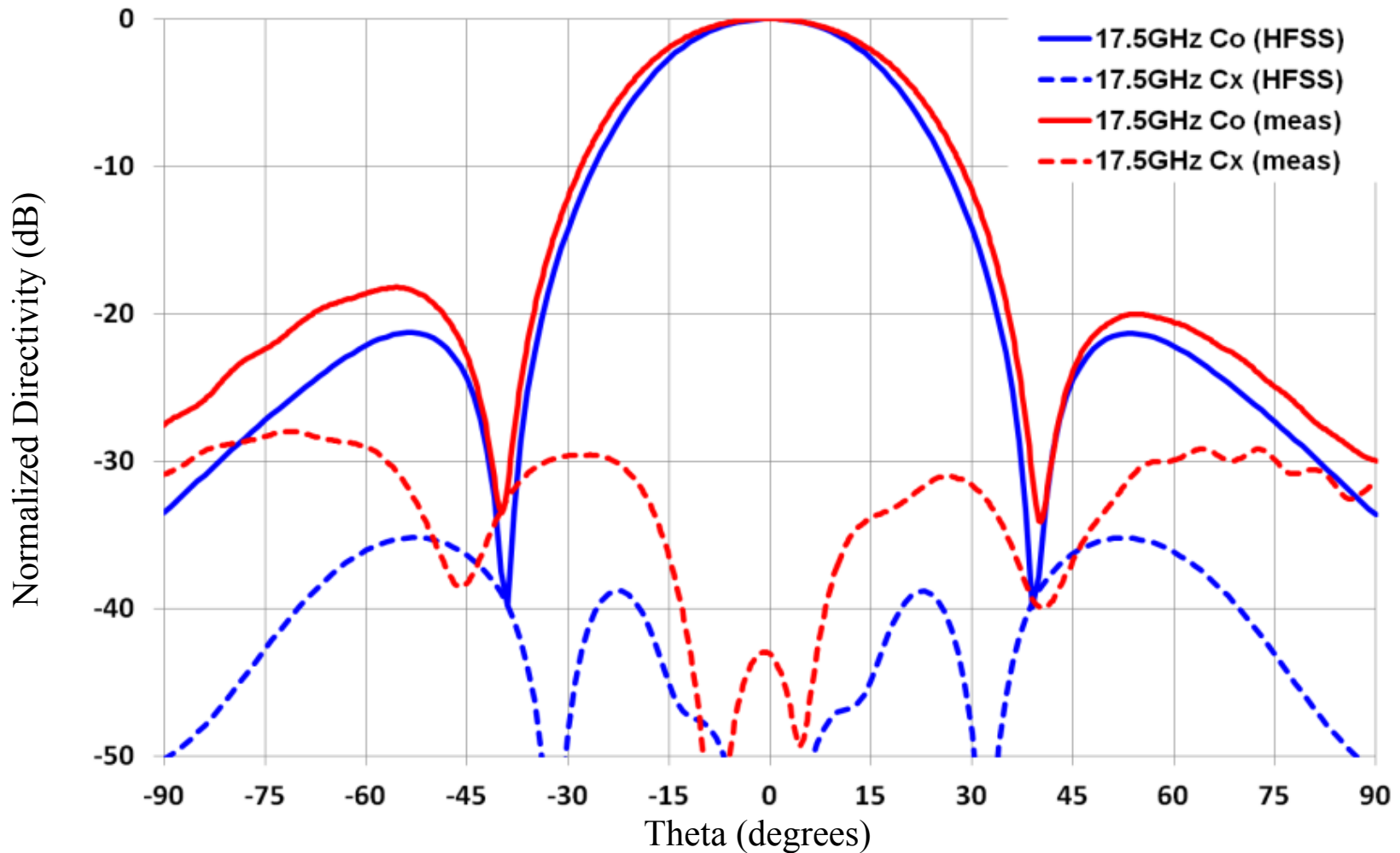

Measurements shown at 17.5GHz GHz, $\phi=0^\circ$. Simulations performed using HFSS.

Wideband Reflector Feed: Antenna Measurements at K-Band

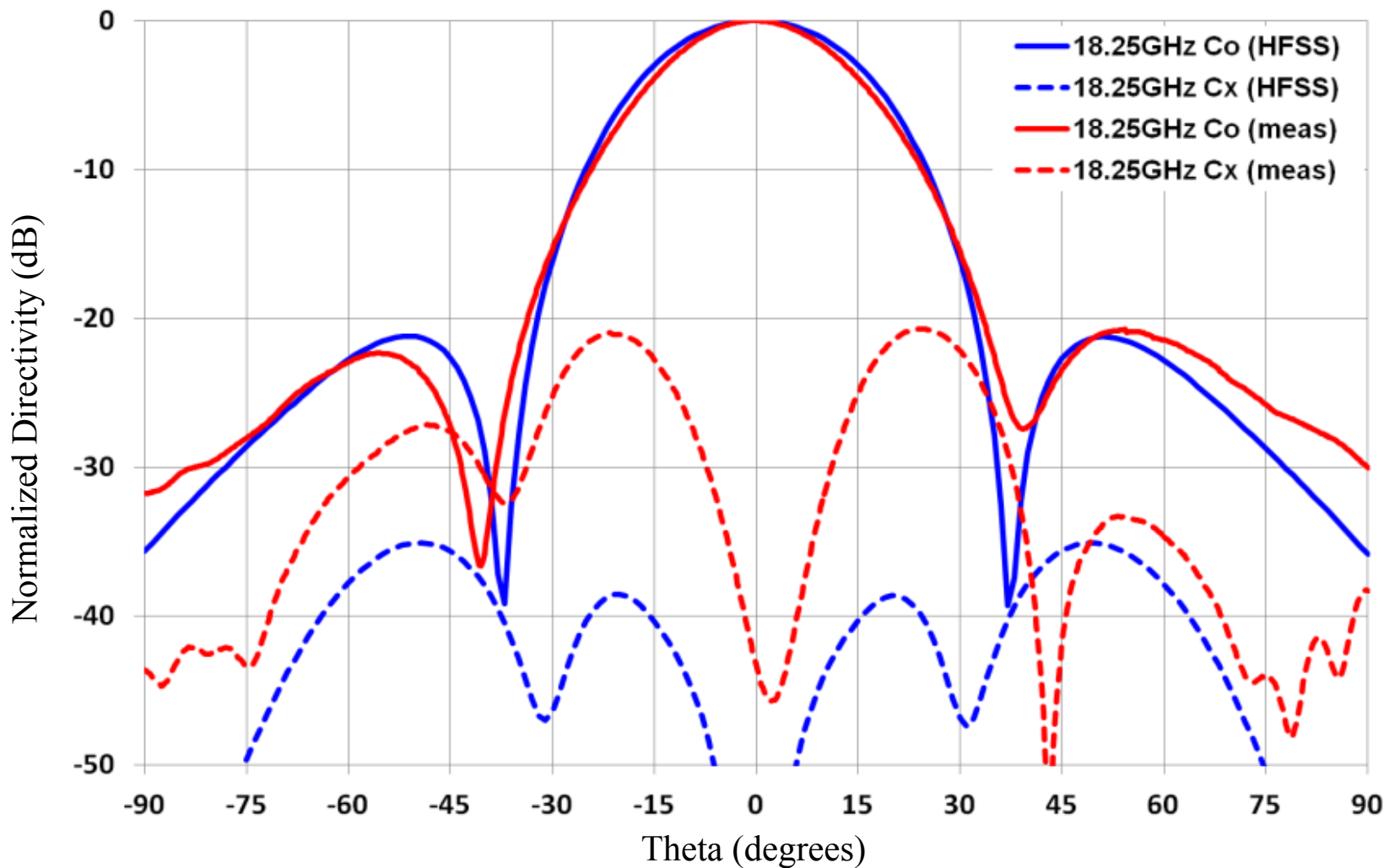

Measurements shown at 18.25GHz GHz, $\phi=0^\circ$. Simulations performed using HFSS.

Wideband Reflector Feed: Antenna Measurements at Ka-Band

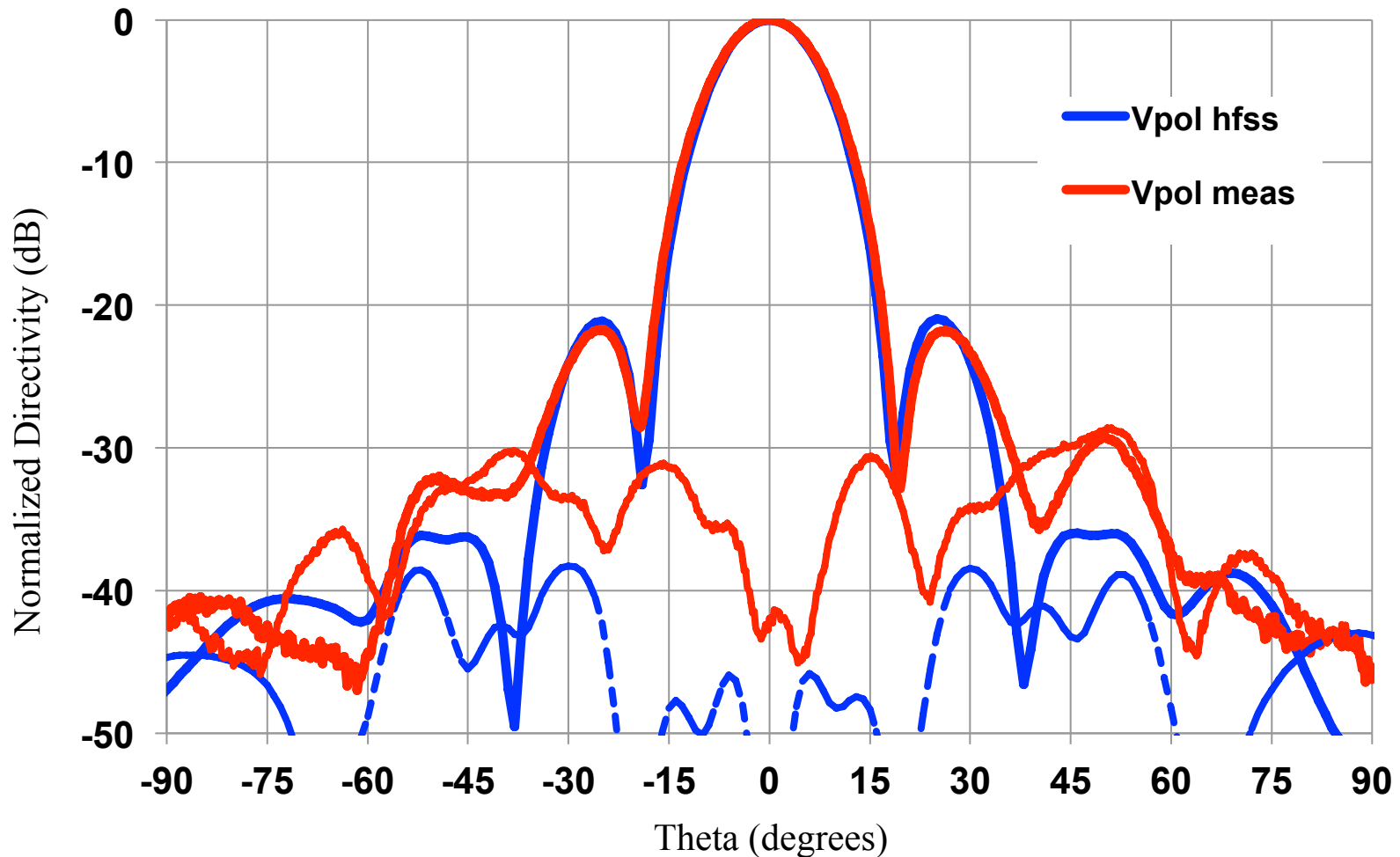

Measurements shown at 36.5GHz GHz, $\phi=0^\circ$. Simulations performed using HFSS.

WISM Reflector

- Reflector design carried out using TICRA GRASP
- Built of polished machined aluminum

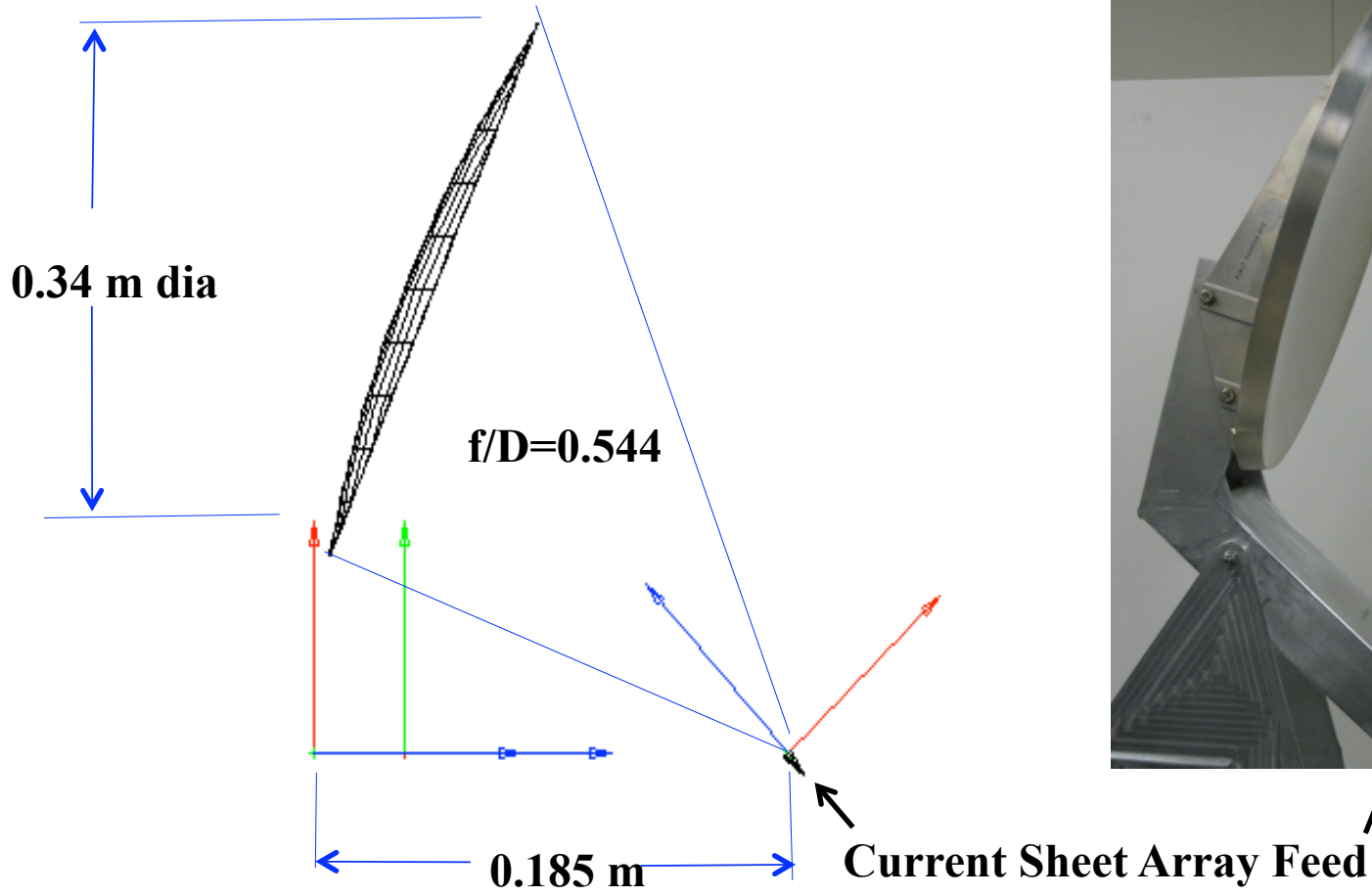

Final Aperture/Reflector Configuration: Secondary Pattern Predictions

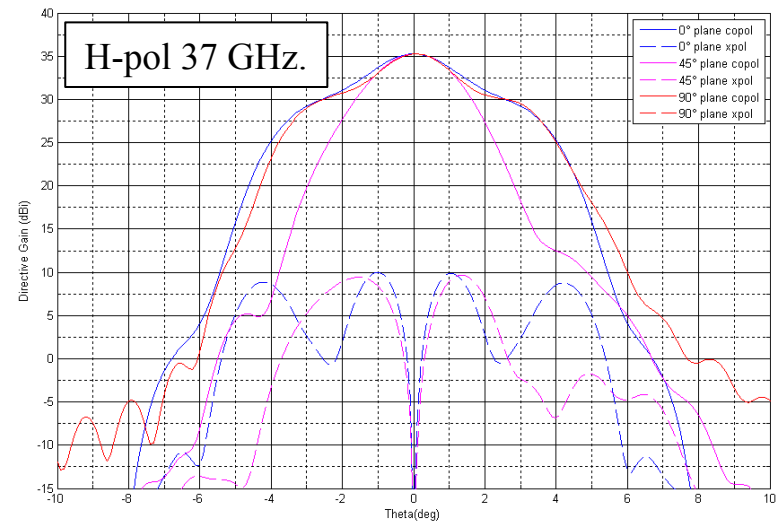
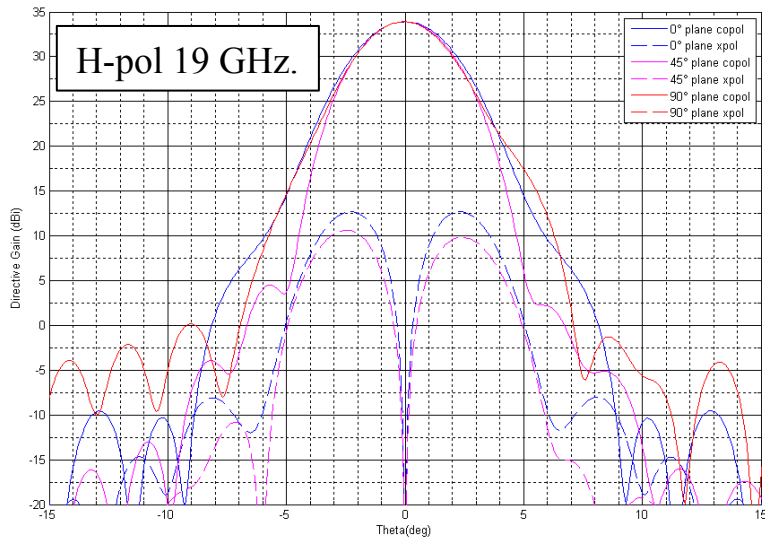
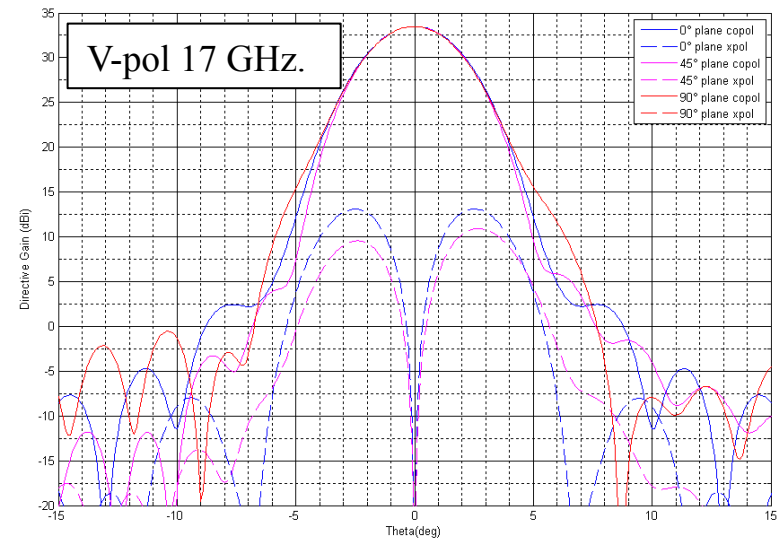
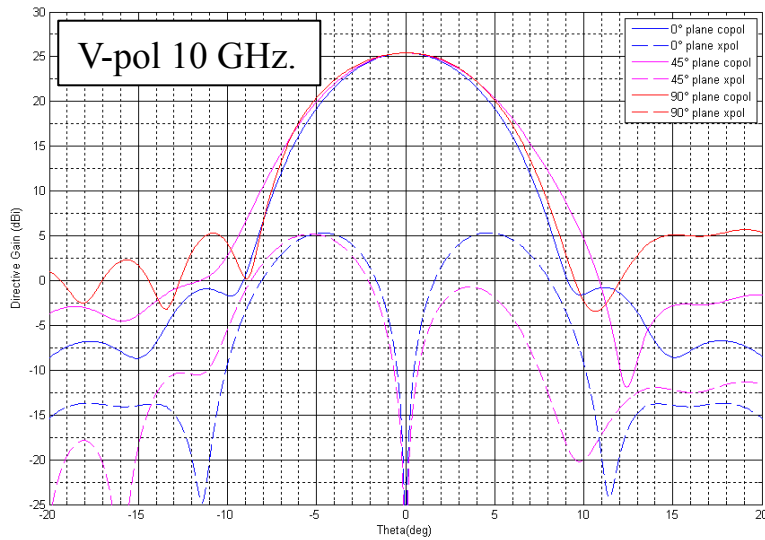

Final Aperture/Reflector Configuration: Secondary Pattern Predictions: Radar Bands Contour Patterns



V-Pol, 10 GHz

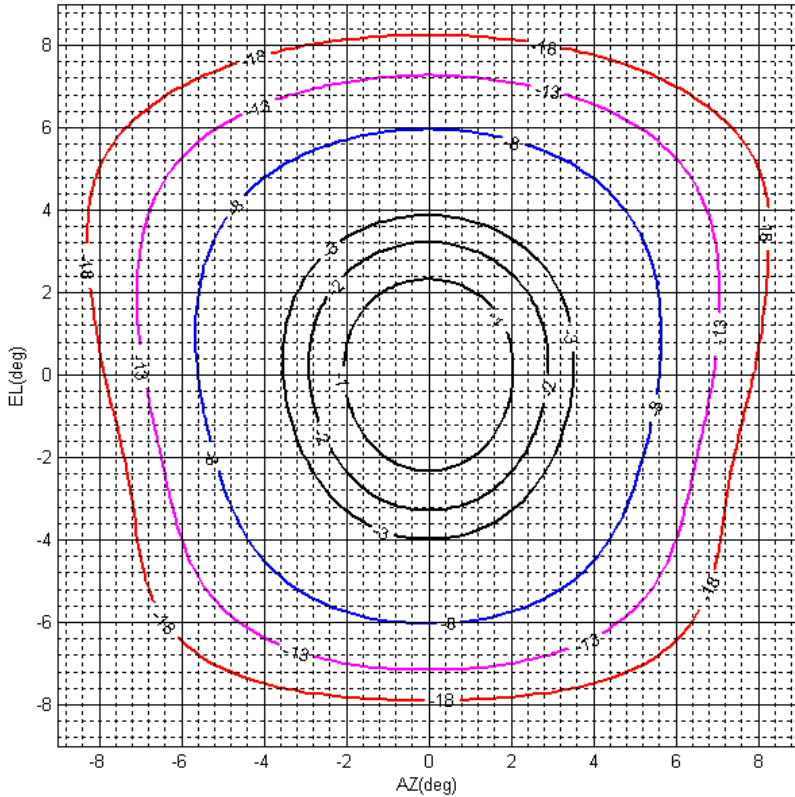

V-Pol, 17 GHz.

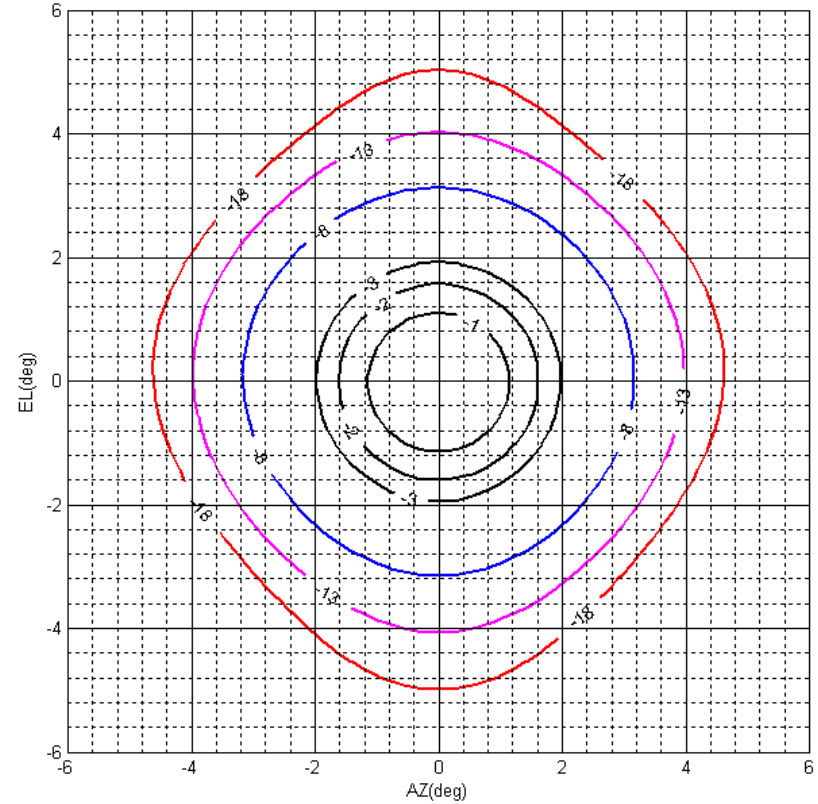

Final Aperture/Reflector Configuration: Secondary Pattern Predictions: Radiometer Bands Contour Patterns



H-Pol, 19 GHz.

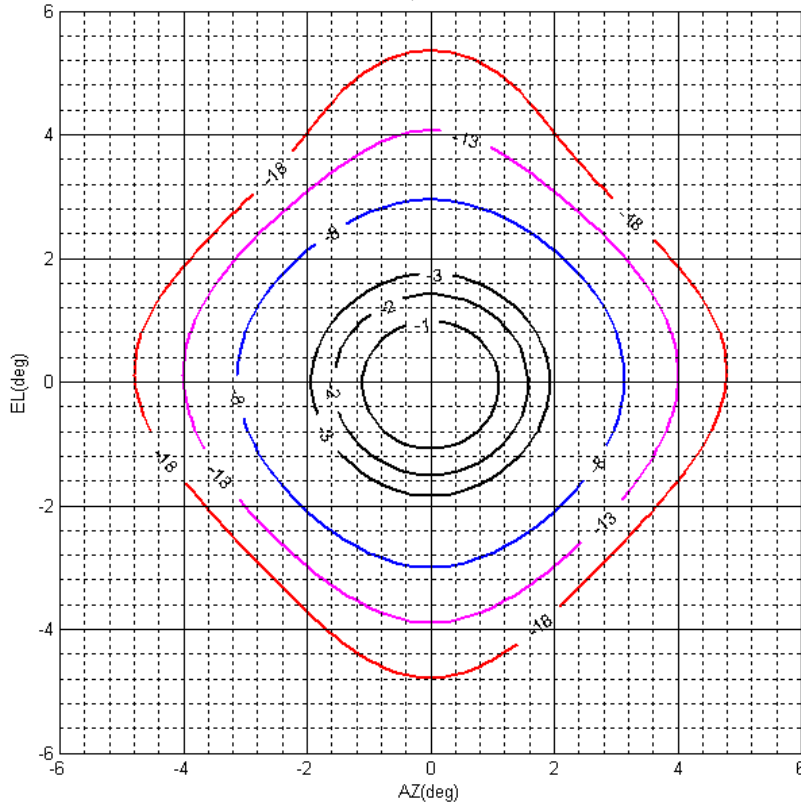

H-Pol, 37 GHz.

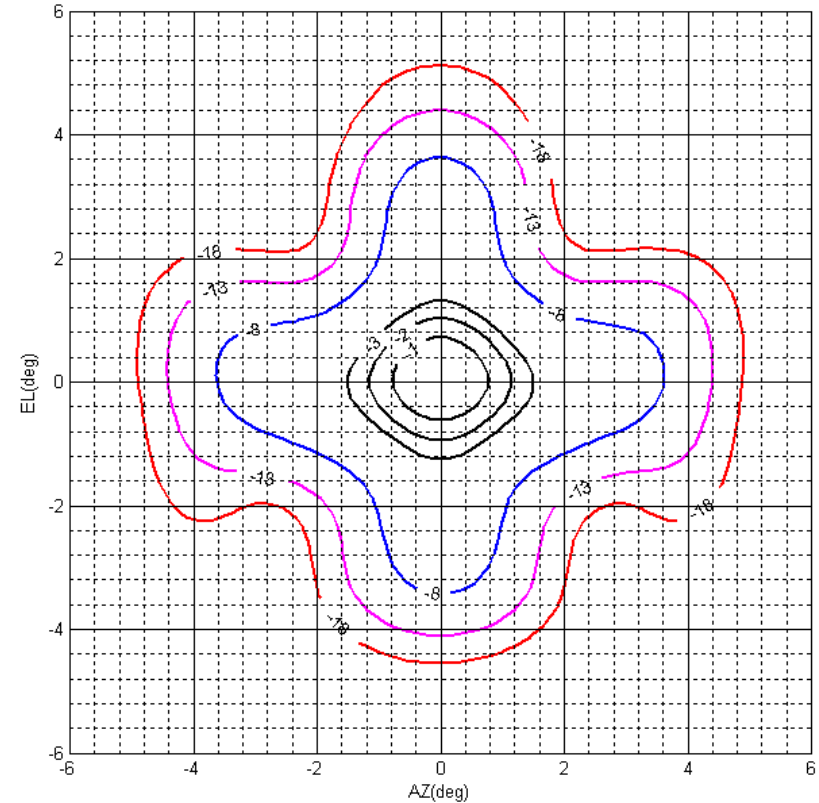

Aperture design reduces beamwidth change with frequency

- Cost constrained on signal processing implementation
- Use evaluation boards and off the shelf commercial components as much as possible
- Leverage SAR algorithm development from legacy code
- Leverage high rate vendor supplied FPGA implementation for sample data collection with some minor modifications to support radar development
- Develop software to integrate radar sampled data with INS/GPS position data



Dual Band Radar

Radiometer Requirements



Requirement	Specification	Notes
Center Frequency (f_c)	36.5 GHz, 18.7 GHz	18.7 GHz band is an expansion of scope
Bandwidth (BW) / Passband	1 GHz / 36 – 37 GHz .3 GHz / 18.6 – 18.8 GHz	Driven by FCC allocation.
Polarization	H	More sensitive to snow layering
Brightness Temperature Range	150 – 250 K	Tsang's analysis; dynamic range anticipated over terrestrial snow
Spatial Resolution	~ 100 m	SCLP SAR requirement
Uncertainty	< 0.5 K	Driven by science
Temperature Resolution $N_e \Delta T$	< 0.3 K	Driven by science
Incidence Angle	45°	Fixed beam with option to point nadir

- Full System Integration and Testing
 - Thermal Stability
 - Overall Functionality of RF Instrumentation Demonstrated
 - Data Retrieval And Post Processing
- Successful Development of Radiometer Subsystems
 - Power System
 - Thermal System
 - RF Instrumentation and Electronics
 - Data-System
- Instrument Benchtop Testing
 - Data Retrieval
 - Analysis of Data
 - Post-Processing Application in Development

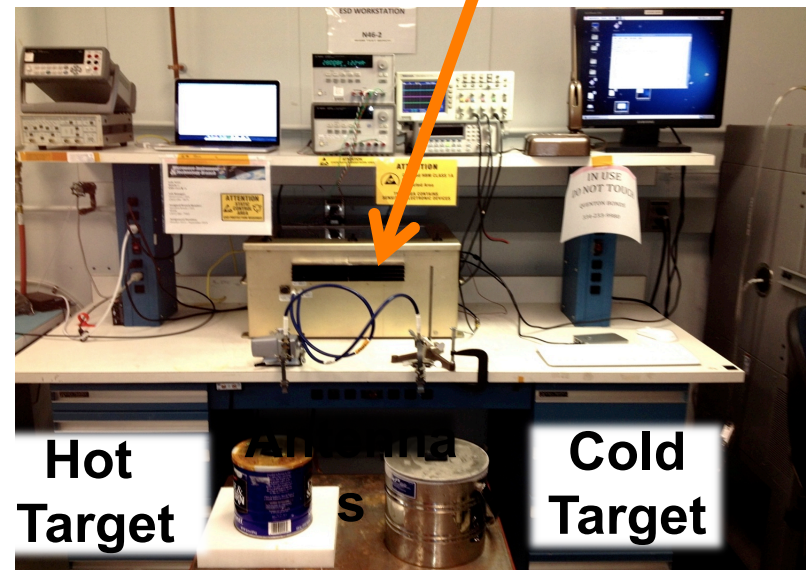
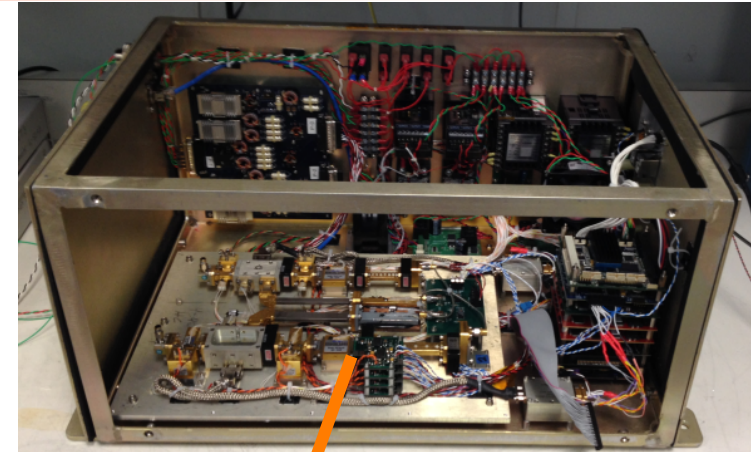

GSFC Radiometer Accomplishments



- Full System Integration and Testing
 - Thermal Stability
 - Overall Functionality of RF Instrumentation Demonstrated
 - Data Retrieval And Post Processing



- Instrument Benchtop Testing
 - Data Retrieval
 - Analysis of Data
 - Troubleshooting of Glitches in Data
 - Post-Processing Application in Development

- Successful Development of Radiometer Subsystems
 - Power System
 - Thermal System
 - RF Instrumentation and Electronics
 - Data-System

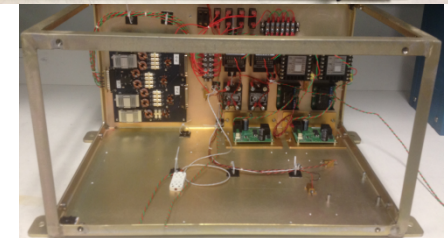
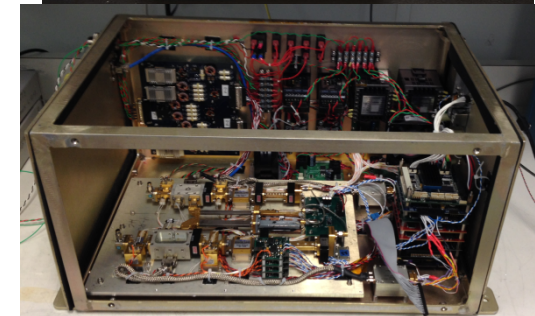
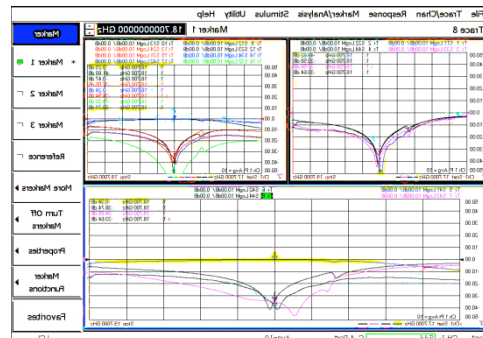

DH-6 Twin Otter Installation - Details **HARRIS**

TOI very experienced in flying scientific missions; 40 – 50 per year

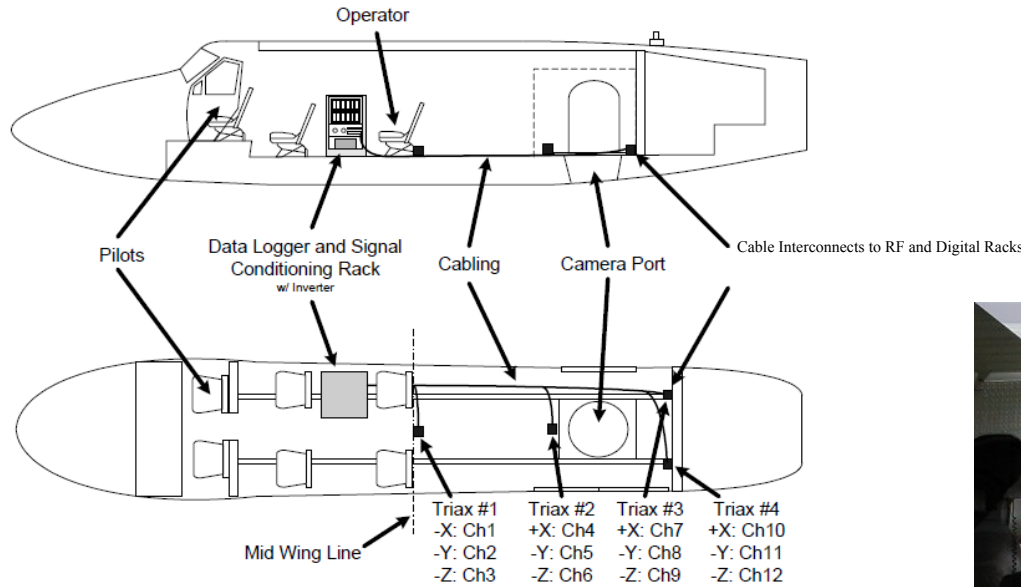

3.5 Coordinate System Convention

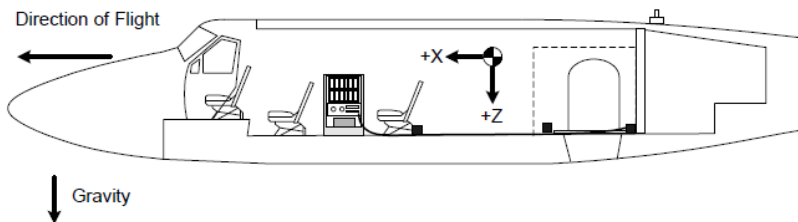

Removable Cargo Door (Either Side)

WISM system designed for an airborne environment

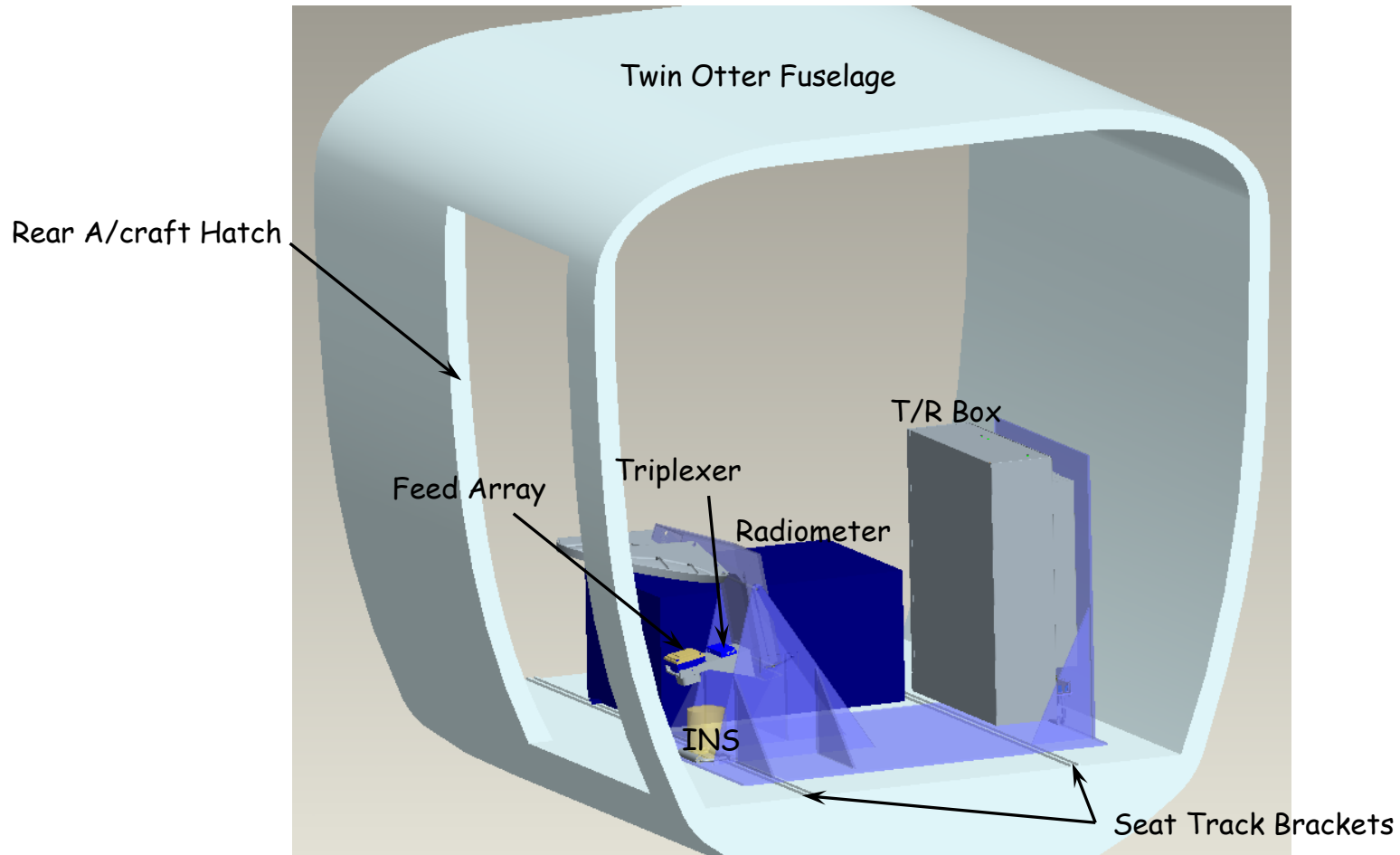

- The work performed on this program demonstrated that an integrated passive wideband (5:1) array can be built using Nuvotronics micro-machining processes
 - Meets requirements for active/passive remote sensing
 - Modular approach for aperture enhances design flexibility
 - Reduces SWaP considerably over competing technologies
 - Allows for co-boresighting of beams
 - Processes were developed on this IIP that will allow previous strata height limitations to be increased for future work
 - Allows for lower frequency operation
- Dual band radar development made novel use of evaluation boards, COTS parts, and existing software to achieve performance goals within budget
 - Allows for instrument to remain intact for future tests/experiments
 - Instrument very amenable to enhancement
- Dual band radiometer developed that is compatible with integration into the radar system
 - Allows for near simultaneous sensing with all four sensors
 - Enhances science value by imaging same snow

- The following were proposed for a 2013 IIP, which has been awarded:
 - Perform a series of enhancements (next slide) to the existing WISM to improve performance, demonstrate reconfigurability, and enhance science value
 - Airborne testing with SAR/Radiometer
 - First year testing with existing WISM
 - Second and third year testing with enhanced WISM
- Success with the airborne campaign would set the stage for proposing sub-orbital (EV) or orbital (CASIS) experiments

2013 IIP Proposed WISM Enhancements



<i>Summary of Proposed WISM Enhancements</i>			
WISM Enhancement	Instrument component affected (responsible organizations):	Implementation	Science/Performance Justification
Add additional radar frequency of operation at 13.6 GHz (Ku Band)	Radar (Harris)	Additional up/down converters, digital hardware and software modifications	Obtain data at additional frequency to reduce sensitivity of SWE inversion to grain size
Add X-band receiver to radiometer	Radiometer (GSFC)	Repackage radiometer to accommodate receiver, diplexer, electronics	Improve sensitivity of passive measurements to thick snowpack, add band overlapping radar frequencies
Through-the-antenna noise injection	Radiometer (GSFC)	Modulated broadband external noise source injected to include CSA feed	Calibrate thermal emission due to front end losses
Improve radar calibration	Radar (Harris, BSU)	External calibration with corner reflectors, noise floor calibration using injected noise, analysis supporting improved calibration	Achieve radar scattering measurement accuracies that correspond to cm level SWE measurement accuracy
Lower loss in CSA ahead of radiometer receiver	CSA Feed (Harris, Nuvotronics, GRC)	Reduce loss in waveguide (see text); improve component designs (i.e., splitters, baluns) and integrate into antenna; investigate active component integration (i.e., switches, LNAs) into antenna	Improves radiometer measurement by lowering front-end losses
Improve Beam Efficiency at radiometer bands (goal of > 95%)	Reflector (Harris)	Shape reflector for improved efficiency	Improves radiometer measurement accuracy by reducing extraneous noise
	CSA Feed (Harris, Nuvotronics, GRC)	Control aperture amplitude distribution (investigate symmetrically scalable CSA)	
Improve aperture efficiency (goal of >85%)	CSA Feed (Harris)	Reduce unit cell spacing and optimize unit cell design	Reduces instrument power consumption and lowers ambiguity due to reflected power
Step scan capability to provide multiple beams	CSA Feed, Radar/radiometer electronics (Harris, GSFC)	Perform analysis of step scan options; possible limited implementation for airborne demonstration	Provides more coverage area per pass for airborne measurements; required for global coverage from space

- Measured in lab with 2.4-mm coaxial cable calibration and no time gating applied.

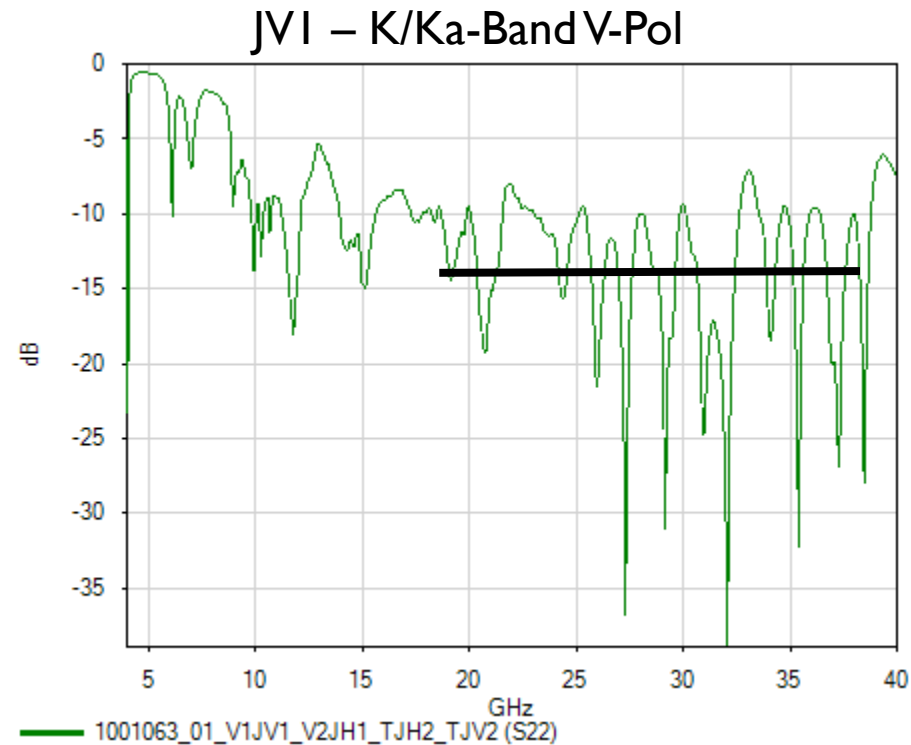
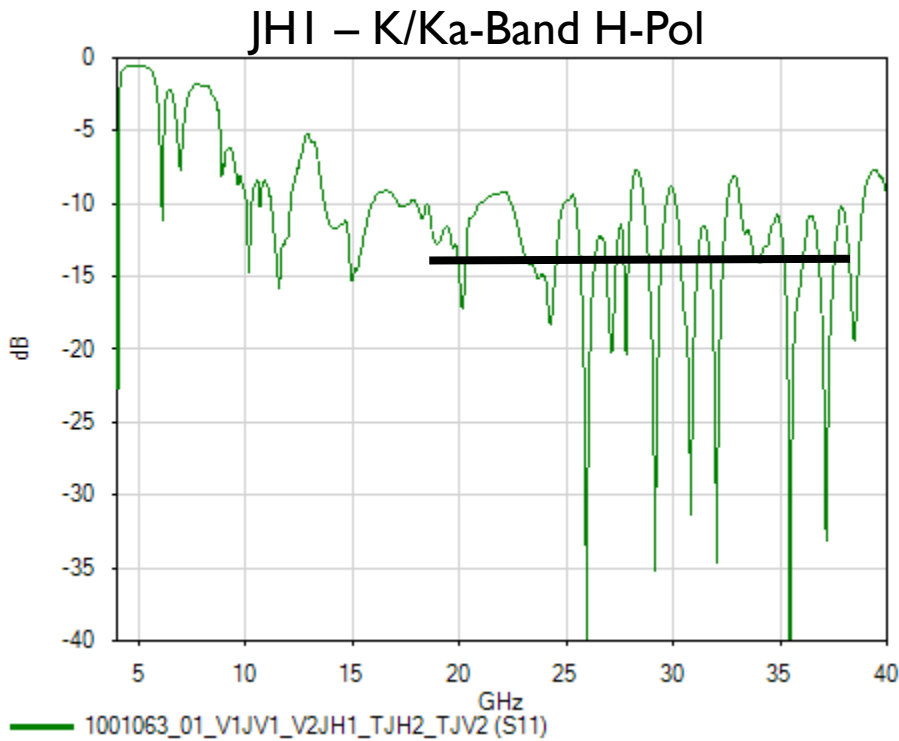
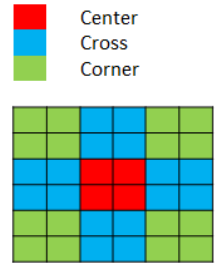

Thank You

Dr. Tim Durham, PI
Antenna Systems Engineer
Harris Corporation
tdurham@harris.com
+1-321-729-7775

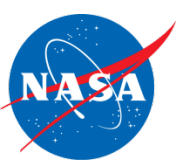

An 8-40 GHz Wideband Instrument for Snow Measurements (WISM)

PI: Tim Durham, Harris Corporation

Objective

- Develop a wideband instrument (8-40 GHz) in support of Snow and Cold Land Processes (SCLP) mission as defined by the Decadal Survey.
- Perform both ground (Radar) and airborne experiments (Synthetic aperture radar/radiometry) using wideband passive arrays.
- Demonstrate improved Snow Water Equivalent (SWE) measurements from ground and airborne experiments using new processing algorithms.



8-40 GHz Antenna



Dual Band Radar

Dual Band Radiometer

Accomplishments

- Designed, built, and tested an 8-40 GHz wideband feed using Nuvotronics Polystrata process
 - Two major builds completed with four total antennas delivered
 - Arrays constructed using modular approach*
- Designed and built reflector
- Feed integrated into reflector
 - Precision alignment with CMM
 - Antenna performance proven with radar in lab/demo
- System specifications generated based on science requirements
- Multi-band Instrument design
 - Dual band Radiometer design, build and lab testing completed
 - Dual band Radar design, build, and lab/demo testing completed using program procured parts
- Successful ground SWE demonstration with both ESM and Alpha Build antennas (Boise State)*
- Wideband SWE algorithms developed

Co-Is/Partners

Leung Tsang, Univ. of Washington; Paul Racette, GSFC; Felix Miranda, GRC; Hans-Peter Marshall, Boise State Univ.; Ken Vanhille, Nuvotronics

TRL_{in}=3

TRL_{out}=4

Enhancement, Validation, and Demonstration of the Wideband Instrument for Snow Measurements (WISM)



- Advance the utility of a wideband active & passive instrument (8-40 GHz) to support the snow science community
- Improve snow measurements through advanced calibration and expanded frequency of active & passive sensors
- Demonstrate science utility through airborne retrieval of snow water equivalent (SWE)
- Advance the technology readiness of broadband current sheet array (CSA) technology for spaceflight applications

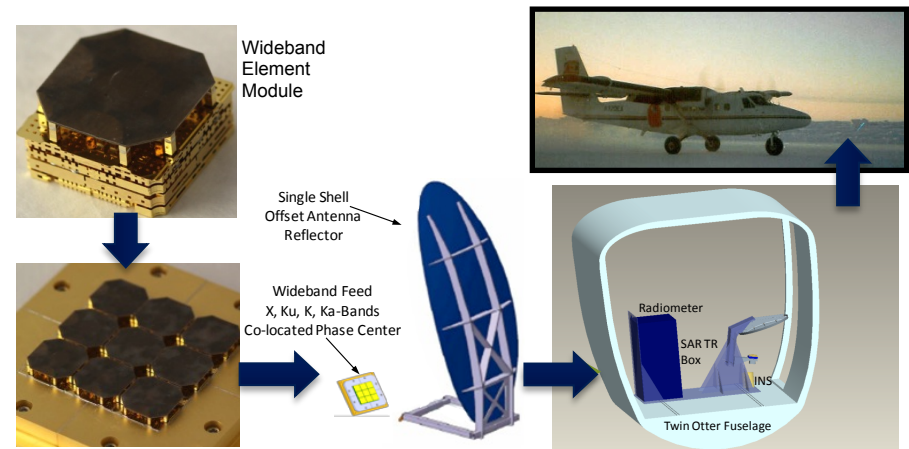

Enabled by advanced CSA technology, WISM is a new broadband multi-function research instrument for NASA's snow remote sensing community

- Calibrate CSA using noise injection.
- Use ground-based corner reflectors for radar calibration
- Add X-band radiometer and Ku-band SAR to instrument
- Conduct three flight campaigns including mapping airborne Lidar and extensive ground measurements to validate retrievals
- Optimize design of CSA for improved loss, beam/aperture efficiency, and scalability

- Add calibration of radiometer using wideband noise injection 11/14
- Conduct engineering flight campaign 01/15
- Add an additional frequency to both radar and radiometer 08/15
- Conduct 1st science flight campaign (dry land) 10/15
- Conduct 2nd science flight campaign (snow) 04/16
- Complete design/build of 2nd generation CSA 10/16
- Complete data analysis & generate science data products 12/16

TRL_{in} = 4